



REMA



Product features and advantages

- > Reliable power connection solution for
 - > Electric vehicle batteries
 - > Battery chargers
 - > Other DC voltage applications
- > Operating voltage determined by housing color
 - > Simplifies mating of same voltages
- > Plug and socket with identical housing design
 - > Reduces quantity of components
 - > Reduces purchasing and storage cost
- > Acid resistant housing material
- > Strain relief available
- > CE Marking & UL recognized
- > Contacts sized for AWG (American Wire Gauge)
- > REMA developed high-grade contacts made out of pure high conductive Cu-ETP copper with silver plated surface and an anti-friction and tarnish coating ensure
 - > power transition with minimal losses
 - > long life
 - > suitable for crimping



REMA

STRUCTURE AND ITEM NUMBERS

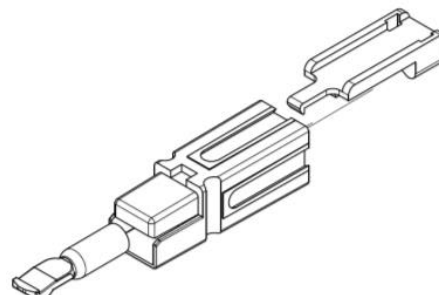

Complete connector

COLOR	MC15	MC30	MC45	MC75			MC120	MC180		
	16 AWG	12 AWG	10 AWG	10 AWG	8 AWG	AWG6	2 AWG	4 AWG	2 AWG	1/0 AWG
> red	109537	109516	109531	109546	110920	109541	109547	111457	111458	109552
> black	109538	109518	109532	111448	110921	109542	109548	---	111459	109553
> white	109539	109517	109533	111449	111451	109543	109549	---	111460	109554
> green	111444	109519	109534	111450	111452	109544	109550	---	111461	109555
> blue	109540	109520	109535	110404	111453	109545	109556	---	111462	109551
> yellow	104286	109521	111447	---	---	111454	109557	---	---	111463
> orange	111445	111446	109536	---	---	111455	111456	---	---	111464

Single housing

COLOR	MC15/30/45	MC75	MC120	MC180	FARBE	MC15/30/45	MC75	MC120	MC180
> red	102804	109522	109557	109562	> blau	102808	109526	109561	109565
> black	102805	109523	109558	109563	> gelb	102809	111465	111467	111469
> white	102806	109524	109559	109564	> orange	102810	111466	111468	111470
> green	102807	109525	109560	102814					

Single contact

	MC15	MC30	MC45	MC75			MC120	MC180		
>Crossection / AWG	16 AWG	12 AWG	10 AWG	10 AWG	8 AWG	AWG6	2 AWG	4 AWG	2 AWG	1/0 AWG
>Item-No.	102800	109510	102801	109356	109358	109354	109354	109360	109364	109365

Cable clamp

COLOR	MC15/30/45	MC75	MC120	MC180
>Item-No.	109204	111478	111479	11480



REMA

TECHNICAL SPECIFICATIONS

GENERAL

CONNECTOR MODEL	MC15	MC30	MC45	MC75	MC120	MC180
> Wire size	16 AWG	12 AWG	10 AWG	6 AWG	2 AWG	1/0 AWG
> Current rating I_N ⁽¹⁾	15 A	30 A	45 A	75 A	120 A	180 A
> Voltage rating	600 V	600 V	600 V	600 V	600 V	600 V
> Operating Temperature (incl. self-heating)	-20 °C ... +105 °C -4 °F ... +221 °F					

(1) depending on cross section and installation

MATERIAL HOUSING

	NORM	>PBT/PC-Blend<
> Halogen-free	DIN VDE 0472-815	yes
> Reaction to fire	UL 94	
> UV resistant		V-0
> Ozone resistant		yes
> Creepage current resistance	IEC 60112	225 V

MATERIAL DATA CONTACTS

- > Electrolytic high conductive copper Cu-ETP acc. EN 13601 and silver plated surface



REMA

TEMPERATURE RISE CHARTS

MC30 MC45

The REMA® MC30 connector system is designed for optimum performance when used 12 AWG cable.
The rated operating current is 30 A.

The REMA® MC45 connector system is designed for optimum performance when used 10 AWG cable.
The rated operating current is 45 A.

Depending on the cross section and the laying procedure, the current rating is changed.

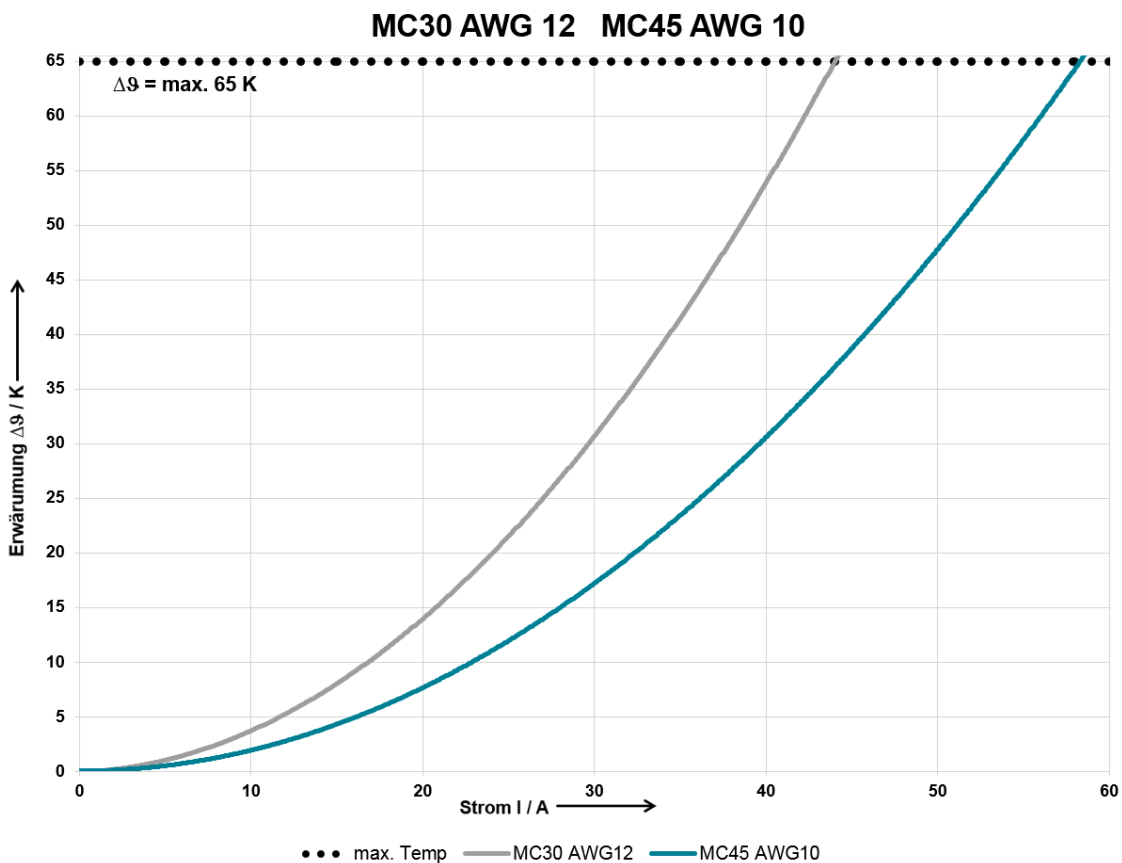

These temperature rise curves are for reference.

The actual thermal performance may vary depending upon environmental conditions.

Please contact Emcomp for additional information concerning the MC30 and MC45.



REMA

MC75

The REMA® MC75 connector system is designed for optimum performance when used 6 AWG cable.
The rated operating current is 75 A.

Depending on the cross section and the laying procedure, the current rating is changed.

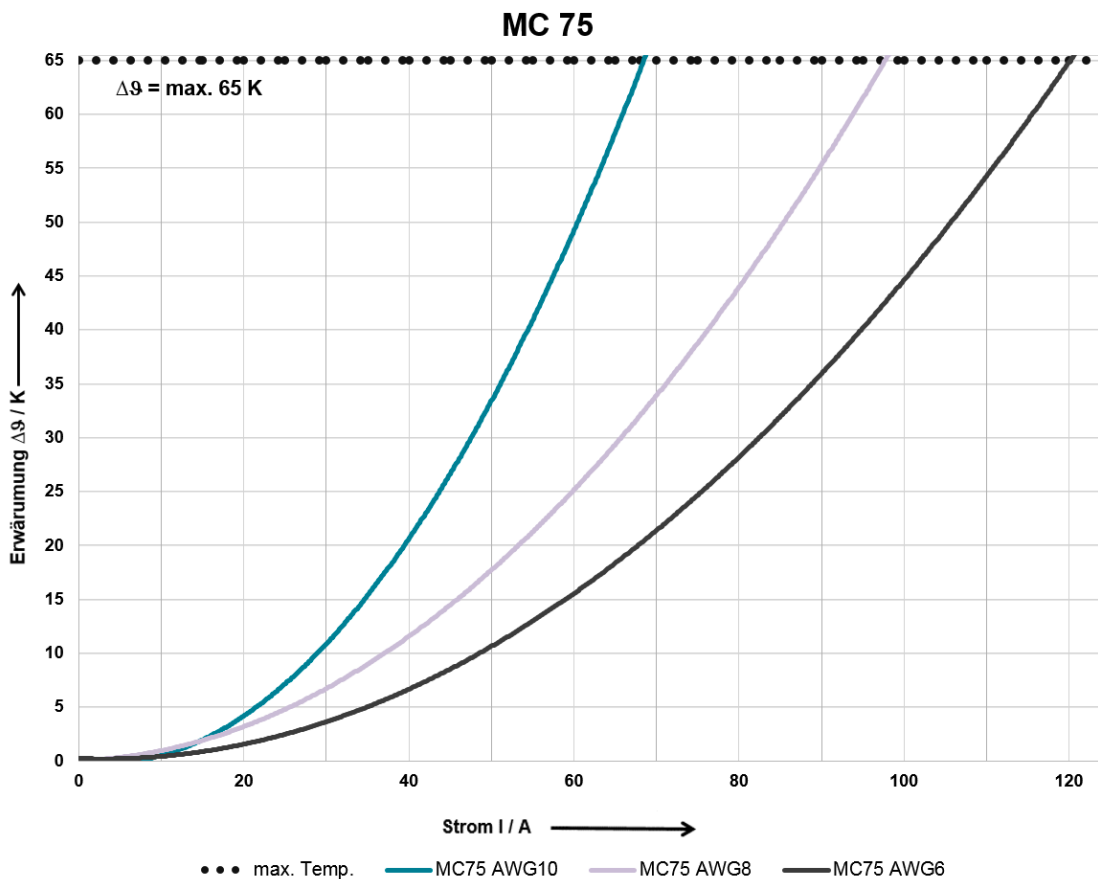

These temperature rise curves are for reference.
The actual thermal performance may vary depending upon environmental conditions.

Please contact Emcomp for additional information concerning the MC75.



REMA

MC180

The REMA® MC180 connector system is designed for optimum performance when used 1/0 AWG cross section cable.

The rated operating current is 180 A.

Depending on the cross section and the laying procedure, the current rating is changed.

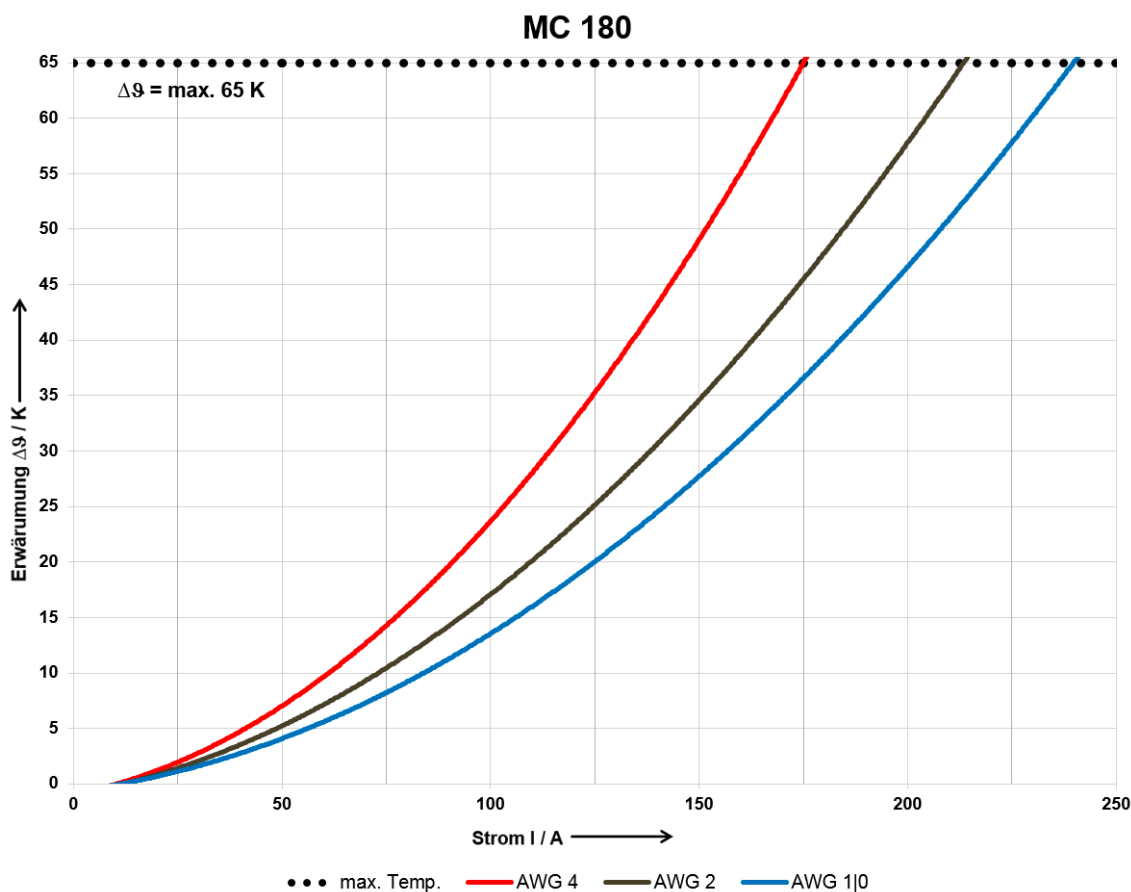

These temperature rise curves are for reference.

The actual thermal performance may vary depending upon environmental conditions.

Please contact Emcomp for additional information concerning the MC180.



REMA

DRAWINGS

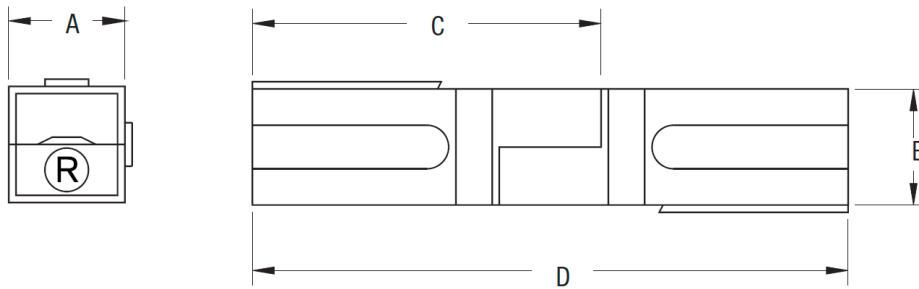

TYPE	A		B		C		D	
	[mm]	[inch]	[mm]	[inch]	[mm]	[inch]	[mm]	[inch]
> MC15/30/45	7,9	0,31	7,9	0,31	24,6	0,96	41,3	1,62
> MC75	15,9	0,62	15,9	0,62	47,6	1,87	81,4	3,20
> MC120	22,2	0,87	22,2	0,87	69,9	2,75	117,5	4,62
> MC80	28,6	1,12	28,6	1,12	82,6	3,25	139,7	5,50



REMA

GENERAL PROCESSING INFORMATION MC15/30/45 MC75 MC120 MC180

Installation of contacts and connector by a qualified electrician in accordance with national and local electrical codes and the following instruction only. Crimp contact to the cables according to the ´s assembly instructions. The following instructions serve as a reference.

> 1.Strip wire

- > Select the correct strip length from table 1
- > Do not cut into cable strands

> 2. Crimpverbindung an den Kabel

- > Select contact from table 1
- > Use REMA recommended tools only
- > Attention: Ensure contact plane remains unchanged after crimping otherwise misalignment will occur, resulting in possible contact overheating

> 3. Insert the wired contact into the rear of the hosing according to picture 2

- > Make sure that the smooth contour of the contact is upwards so that the contact underside moves over the housing spring (picture 2) and is retained with an audible click.
- > To check engagement, pull gently on the cable to make sure contact is correctly locked over the housing spring

Table 1: Overview Table

TYPE	Contact Item-No.	Wire Size AWG	Strip length „X“ in mm acc. pic. 1	Strip length „X“ in inches acc. pic. 1
> MC15	102800	AWG16	7.4	0,29
> MC30	109510	AWG12	7.5	0,29
> MC45	102801	AWG10	6.4	0,25
> MC75	109356	AWG10	13,5	0,52
> MC75	109357	AWG8	12,5	0,49
> MC75	109356	AWG6	12	0,477
> MC120	109511	AWG2	21	0,81
> MC180	109360	AWG4	26	1,01
> MC180	109364	AWG2	26,5	1,03
> MC180	109563	AWG1/0	26,4	1,02

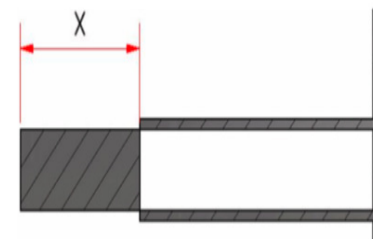

Picture1: Strip length



REMA

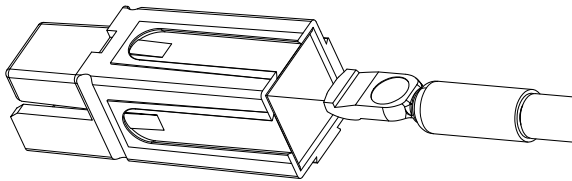

Picture 2: Assembly of wired contact into housing

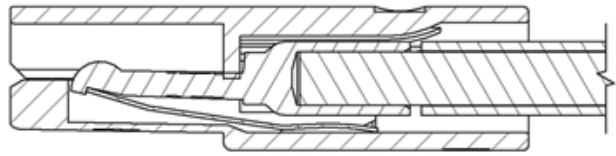

Picture 3: Installed contact into housing

Disassembly

- > Switch off power the contact according to DIN EN 60079-14 when dis-assembling the contact
- > Remove contact by pressing the spring at the front of the connector with a small insulated screwdriver. Simultaneous while pressing the spring, pull gently on the cable to remove the contact from the housing

**REMA**

DIE SETS

General processing information

- Please only use original REMA die sets. Only those guarantee a secure electrical connection.
- Please actuate the REMA made - die sets always until the end.
- Only process contacts with clean sleeves. The contaminated crimpsleeves increase the contact resistance and may lead to overheating.
- REMA made - die sets are manufactured from hardened tooling steel and have a long life cycle. Nevertheless they must be monitored regularly if under heavy use. REMA is glad to advise you about the service life assessment of your die sets.

REMA offers an electrical and a microscopic analysis of your crimp samples upon request.
- Please always set the die sets centred on the crimp sleeves



Extract of the available crimping range

TOOL	CROSS SECTION	DIE SET TYP	DIE SET ITEM-NO.
> Mechanical hand-operated tool MPD-RMC 15/75	12 AWG	Hexagonal	107132
> Mechanical hand-operated tool MPK 16	10 AWG for MC45	Indent	102280
> Compression head C60 ST	10 AWG for MC75	Indent	107044
> Compression head C60 ST	8 AWG für MC75	Indent	107045
> Compression head TPK 130	6 AWG for MC75	double indent	107182
> Compression head TPK 130	4 AWG for MC180	double indent	107187
> Compression head TPK 130	2 AWG for MC180	double indent	107191
> Compression head TPK 130	1/0 AWG for MC180	double indent	107191



REMA

TOOLS AND ACCESSORIES

Mechanical hand-operated tool MPD-RMC 15/75

- Mechanical hand-operated tool with installed hexagon dies
DIN 48083 Bl.44 - KZ 5/6/7
- Ratched type for consistent crimping
- Die sets from 16 AWG to or
1,5mm² to 16mm²



Mechanical hand-operated tool MPK 16

- Mechanical hand-operated tool with installed indent dies
- Ratched type for consistent crimping
- Die sets from 0,75mm² to 16mm²



REMA

Hydraulic Table compression head TPK 130

- Workshop capable version for frequent use
- With hydraulic-cylinder for connection to hydraulic pumps
- Incl. coupling male
- For double deep die sets from 16 mm² to 120 mm²
- For total cable diameter up to Ø 38 mm
- Working pressure: max. 700 bar
- Force of pressure: 130 kN

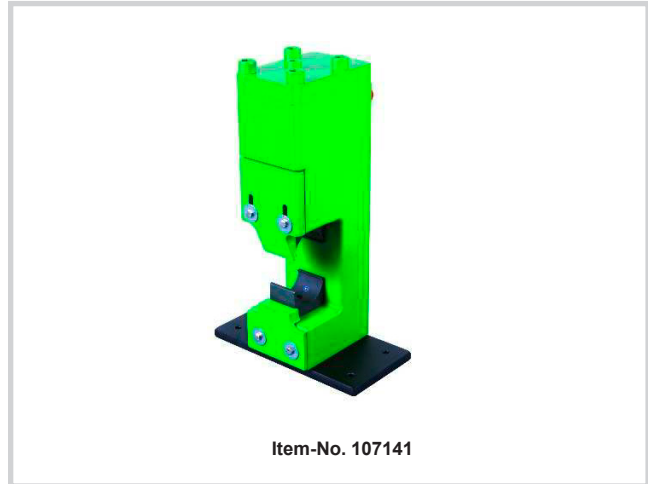

Hydraulic compression head CG 130

- Mobile version for work on site
- With hydraulic-cylinder for connection to hydraulic pumps
- Incl. coupling male
- For double deep die sets from 16 mm² to 120 mm²
- For total cable diameter up to Ø 38 mm
- Working pressure: max. 700 bar
- Force of pressure: 130 kN



REMA

Hydraulic compression head H 250 incl. adapter H250/130

- Mobile version for work on site
- With hydraulic-cylinder for connection to hydraulic pumps
- Incl. coupling male
- For double deep die sets from 16 mm² to 240 mm²
- For total cable diameter up to Ø 38 mm
- Working pressure: max. 700 bar
- Force of pressure: 250 kN



Electro hydraulic pump EP 2 W

- Operating voltage 230 V AC | 50 Hz
- Total compact self-contained model
- Suitable for hydraulic compression heads
CG 130 and H 250 and more REMA® compressionheads
- Working pressure: max. 700 bar
- Mechanical and electrical pressure relief valve
- With 1,5 m hose incl. female quick coupler





REMA

Electro hydraulic pump EP 4 WF

- > Operating voltage 230 V AC und 400 V AC (50Hz)
- > Total compact self-contained model
- > Suitable for hydraulic compression heads CG 130 and H 250 and more REMA compression heads
- > Working pressure: max. 700 bar
- > Mechanical and electrical pressure relief valve
- > Independent electrical control sequence
- > Off switch with emergency off switch as a footswitch
- > Especially for workshop operation and mass production



VOLTAGE	ITEM-NO.
230 V AC 50 Hz	111349
400 V AC 50 Hz	111350

Hydraulic foot-operated pump FP 3

- > Double piston pump with automatic change-over
- > With pressure relief valve
- > By interchanging preselected pressure hoses



MODEL	ITEM-NO.
With female quick coupler	111351



REMA

High pressure hose with coupler



LENGTH	COATING	CONNECTION	ITEM-NO.
2 m	steel (not isolated)	extension	107101
3 m	steel (not isolated)	extension	107102
4 m	steel (not isolated)	extension	102353
5 m	steel (not isolated)	extension	102354